

# nivtec®



## The Staging System

Assembly Instruction Edition 2012

## I. Assembly Instruction nivtec Staging System

This assembly instruction applies for nivtec stages in raster 2x1 m. The assembly described in detail below refers to a sample stage size 6 x 4 m. It can be adopted for any other stage size.

It contains step by step instructions how to assemble stage platforms to a safe and stable stage and how to attach additional nivtec system parts such as stairways, rails etc. You will find additional assembly information in text and images in our general catalogue, chapter "building stages with nivtec".

Safe stability is only guaranteed by exclusive use of original nivtec parts resp. in accordance with nivtec instructions (for example for use of exactly specified Layher parts). All parts used need to be checked to ensure their impeccable condition.

The selected legs should be appropriate for the local ground surface. Depending on the nature of the floor surface it is essential to use floor protectors, especially on slippery or sensible surfaces (concrete, tiles, parquet etc.). Stage constructions may only be set up on stable ground and have to be aligned horizontally. For constructions on rough grounds it is essential to use wooden underpinnings acc. to the standard values listed in DIN EN 13814, item 5.5.4.

For nivtec weight girder stages in raster 2x2m and for nivtec seat galleries detailed part lists and sample drawings are available. We recommend to ask for corresponding information already when planning the base construction. Assembly and attachment of accessories such as rails and stairways is made according to this assembly instruction resp. in accordance with additional information shown in our general catalogue, chapter "building stages with nivtec".

Besides standard stages also specially shaped stages are possible. When planning such stages please contact us in time if due to their individuality the construction deviates from the general instructions and separate structural calculations are necessary. We will then either authorize your plans or instruct our structural engineers to work out an individual measurement and strutting plan at fair local conditions.

## II. Mounting of legs and platforms acc. to nivtec principle

ill. 1: mounting of legs (bottom of platform)

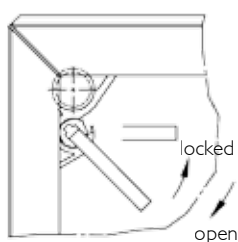

Each nivtec system platform is equipped with 4 leg supports with double eccentric clamping lever.

Mounting of leg: Fit the leg into leg support up to the stop and tighten by pulling the clamping lever (see ill. 1).

ill. 2: connection of platforms

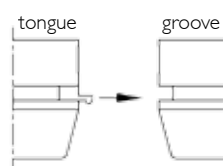

Each nivtec system platform is equipped with 2 tongue profiles and 2 groove profiles. To connect the platforms the tongue profile is hooked into the groove profile. Important: hook tongue into groove profile, not vice versa!

ill. 3: locking of platforms

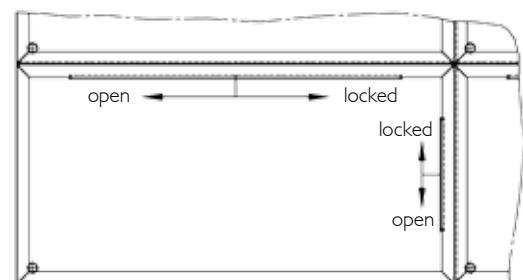

Each nivtec system platform is equipped with the integrated locking mechanism "Klick-Klack". Immediately after the tongue profile has been hooked into the groove profile move the handle bar into position "locked" and check the stability of the platform connection.

## nivtec principle

ill. 4: position of platforms

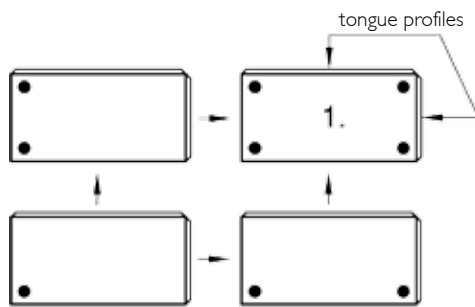

ill. 5: stage example 6 x 4 m

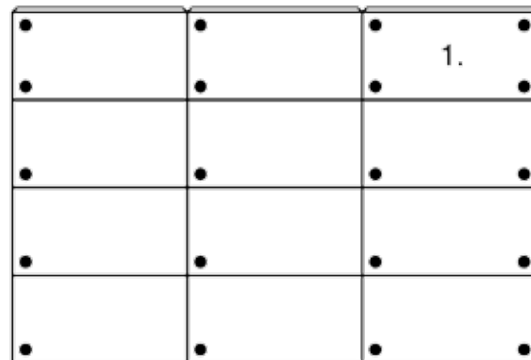

The tongue profiles of all platforms are pointed to the rear and to the right side.

nivtec principle:

position first platform:

right back side - 4 legs

platforms right row:

2 legs at the front at the long groove profile  
(no legs at the back at the tongue profile)

platforms back row:

2 legs at the left side at the short groove profile  
(no legs at the right side at the short tongue profile)

all further platforms:

1 leg at the left front corner of the groove profiles  
(no further legs necessary).

The leg positions as described for a stage 6 x 4 m can be adopted for any other stage size.

## III. height adjustment of stage

There are following possibilities of height adjustment for stages with interchangeable legs:

ill. 6: nivtec-levelling leg with adj. spindle

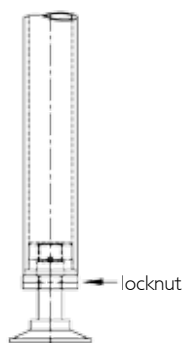

levelling leg with adjusting spindle, adjusting capacity 6 cm, locknut from height 60 cm.

Choose height required - tighten locknut

ill. 7: nivtec extension leg with adj. spindle

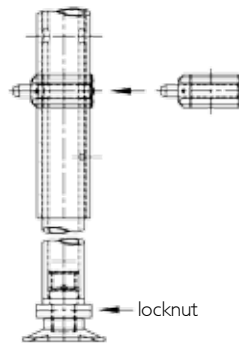

extension leg, height adjustment raster 5cm, adjusting spindle for fine adjustment, with locknut.

Choose height required - insert safety bolt clip - adjust height - tighten locknut

ill. 8: nivtec levelling leg with Layher scaffold spindle

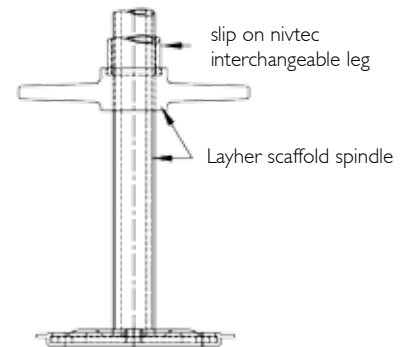

levelling leg with Layher scaffold spindle, stepless height adjustment, max. spindle way for raster 2x1m:

max. 25 cm with spindle 60 cm  
max. 40 cm with spindle 80 cm

You will find bracing instructions for stage height from 80 cm at page 7.

## IV. Assembly of nivtec stairway

ill. 9:

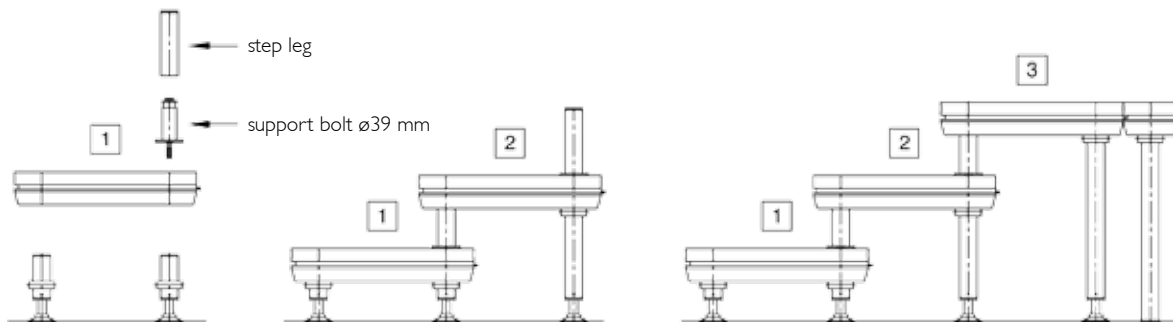

### hook on – stairway

1. For first step insert 4 legs and mount 2 support bolts  $\varnothing 39$  mm, Art.No. 401 01 0 at the back.
2. For second step insert 2 step legs at the front and 2 legs 40 cm at the back. Mount 2 support bolts.  
For further steps use at the back legs 20 cm higher than the previous ones.
3. Hook the tongue profile of the last step into the groove profile of the stage and lock the connection.
4. For attachment of stairway at the tongue profile of a stage either attach a pater lath or turn top step round, hook tongue profile of stage into groove profile of top step and lock connection.

### push on - stairway

Assembly of push-on and hook-on stairway is identical. Exception: for last step use platform with depth 39 cm for achieving a uniform tread. Align stairway to stage.

### connection of stairway and stage at groove profile:

- 1 leg link 110 mm, Art.No. 401 10 0 + 1 special link N-F, Art.No. 402 01 0 or
- 2 special links N-F, Art.No. 402 01 0 (if there is no stage leg)

### connection of stairway and stage at tongue profile:

- 2 leg links 110 mm, Art.No. 401 10 0, if necessary add stage leg

## V.a assembly of safety rails

ill. 10:

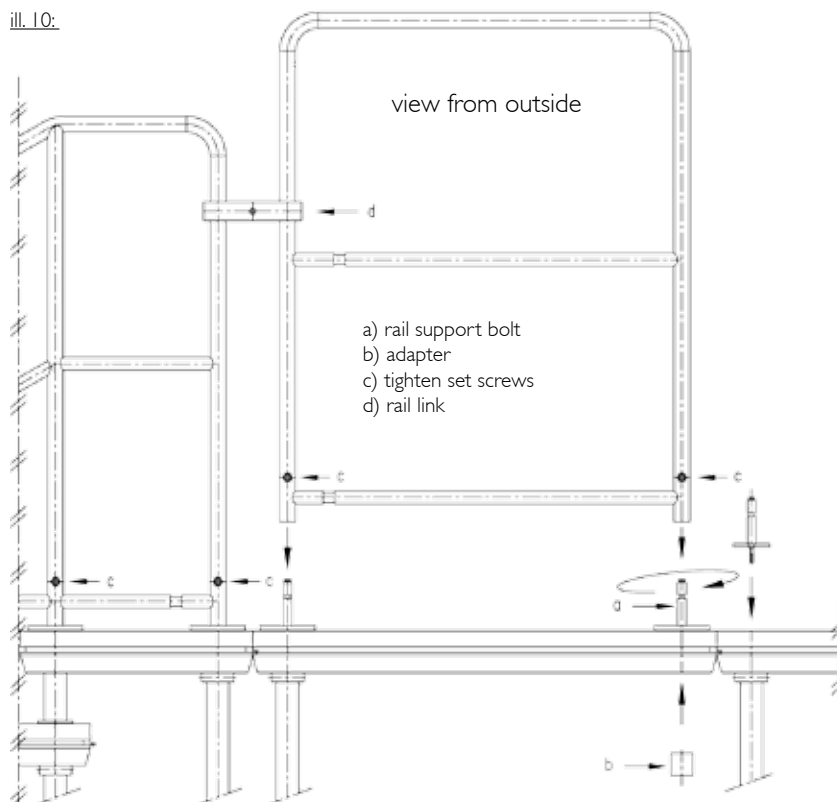

- necessary standard accessories per rail:
- 2 rail support bolts, Art.No. 310 01 0
  - 1 adapter, Art.No. 310 20 0
  - 1 rail links, Art.No. 310 10 0

1. Remove blue caps at top of platform
2. Screw in support bolts  $\varnothing 26$  mm (a) and tighten them with ratchet spanner, size 19.
3. At places without a leg underneath insert thread adapter (b) into leg support
4. Slip rails on support bolts
5. Tighten set screws (c)
6. Attach rail links (d).

Please make sure that rails are connected to each other with rail links resp. corner links at the corners.

## V.b assembly of safety rails 185 cm if lateral load 1 kN/m is required

ill. 10 e): 2 rail links, 150 mm

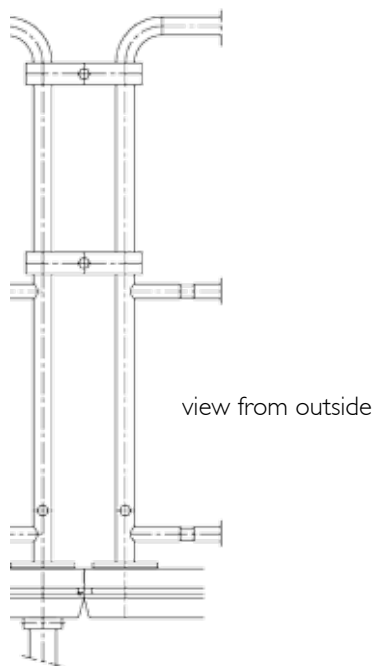

ill. 10 f): 1 rail link, 150 mm,  
reinforced

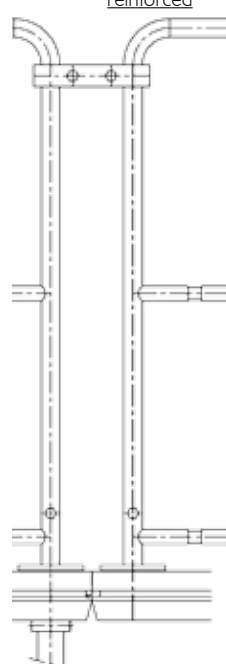

## V.c fastening of rails at

ill. 11: 2 corner links

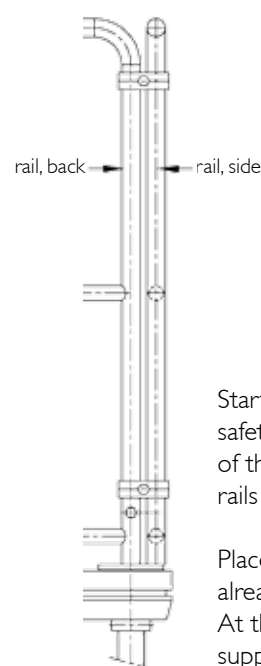

Start the assembly of the safety rail at the rear of the stage. Next the side rails are attached.

Place first side rail beside the already mounted rear rail. At the front slip rail onto rail support bolt.

combined with other rails:

2 rail support bolts, Art.No. 310 01 0 (standard)

2 rail links, Art.No. 310 10 0 (standard – ill. 10e)

or

1 rail link, reinforced, Art.No. 310 10 5 (new – ill. 10f)

as single part:

2 rail support bolts, reinforced, Art.No. 310 01 5 (new)

Side and rear rails have to be connected with two corner links, Art.No. 310 21 0, per corner. Place metal clamps around both rail posts, fit set screw between posts and tighten it.

## VI. fastening of stairway safety rails

ill. 12:

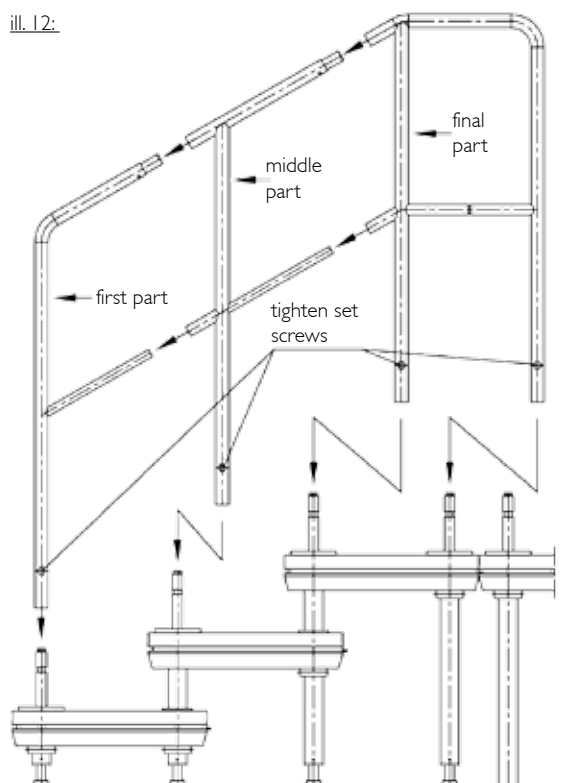

1. Remove blue caps.
2. Screw in rail support bolts (ill. 10 a) and tighten them.
3. Combine first, middle and final parts to form the stairway rail required. Depending on size of stairway size of rail can be adjusted by adding single, double or triple middle parts.
4. Slip complete rail onto support bolts.
5. Tighten set screws. The screws have to be at the outside.
6. For hook-on stairways connect final part of stairway rail and stage rail with rail link 150 mm. For push-on stairways use rail link 110 mm. Tighten set screws.

When attaching stairways take care in closing rail gaps. Special rails are available in various widths such as 50cm and 100cm or final part for hook-on stairway 50cm.

## VII. safety rails with vertical bars – examples:

Attachment of stage safety rails with vertical bars, height 110 cm, and stage safety rails, height 100 cm, is identical.

Stairway safety rails with vertical bars, height 110 cm, are supplied as complete rails according to the size of the stairway (available for hook-on stairways up to max. 6 steps). The attachment is the same as for stairway safety rails, height 100 cm.

The following drawings show examples of stages / galleries equipped with safety rails with vertical bars. Contrary to the method shown in illustration 14 with a rail 85 cm per platform you may also use a rail 185 cm covering two platforms

ill. 13 - example: rails at the back of stages and galleries

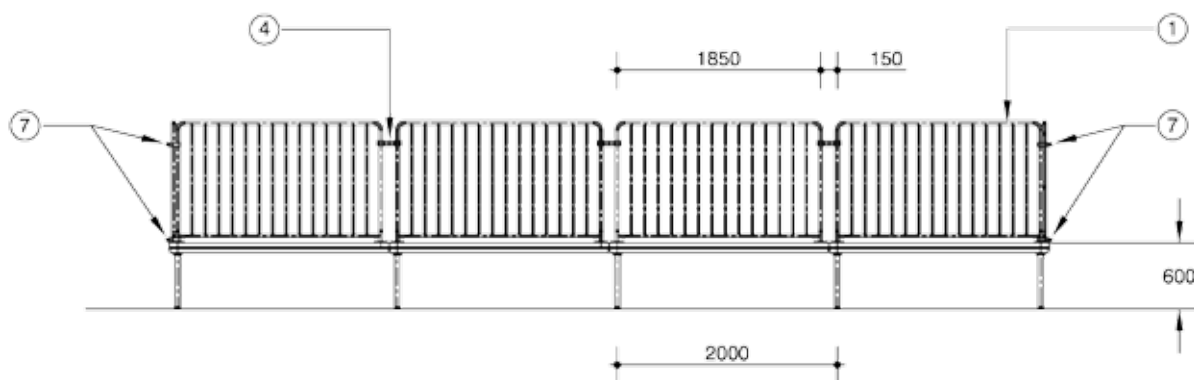

ill. 14 - example: rails at the side of stages and galleries

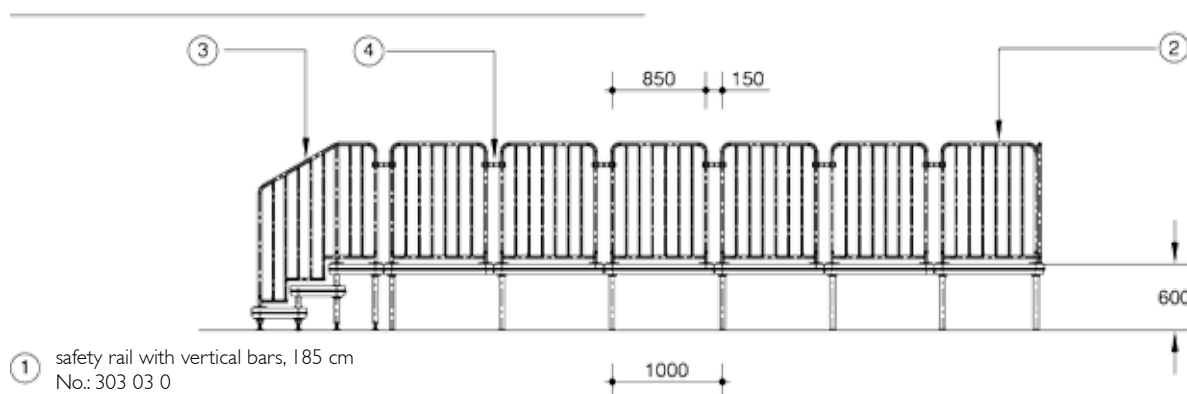

- ① safety rail with vertical bars, 185 cm  
No.: 303 03 0
- ② safety rail with vertical bars, 85 cm  
No.: 303 02 0
- ③ safety stairway rail with vert. bars, 3 steps  
No.: 305 02 1
- ④ rail link, 150 mm  
No.: 310 10 0
- ⑤ rail link, 110 mm  
No.: 310 11 0
- ⑥ leg link  
No.: 401 10 0
- ⑦ corner link  
No.: 310 21 0

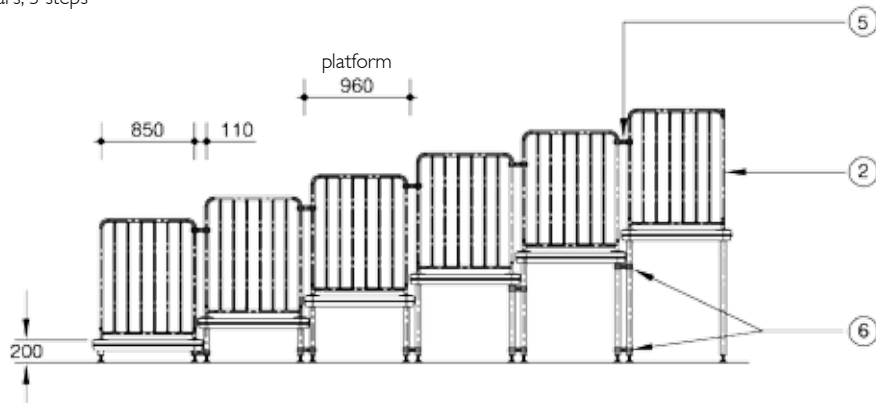

If lateral load 1 kN/m is required for rails 185 cm instructions as per chapter V.b are to be respected.

## VIII. bracing instructions

Base constructions with interchangeable legs from height 80 cm are reinforced with diagonal braces at each corner and in intervals of two free bays at the outside. Braces for stage sizes from 6 x 4 m are to be attached as follows:

- at each stage corner
- at sides with 2 m leg distance: covering one bay (see ill. 15)
- at sides with 1 m leg distance: covering one or two bays (see ill. 17 or 16)
- no more than two free bays in a row are allowed at any stage side

For details regarding required bracing parts and their use please see page 16.

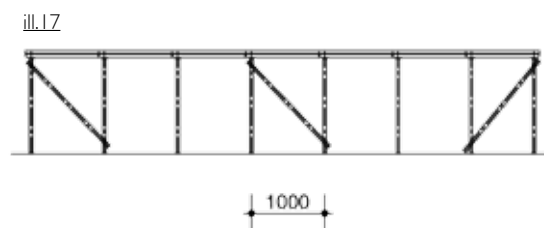
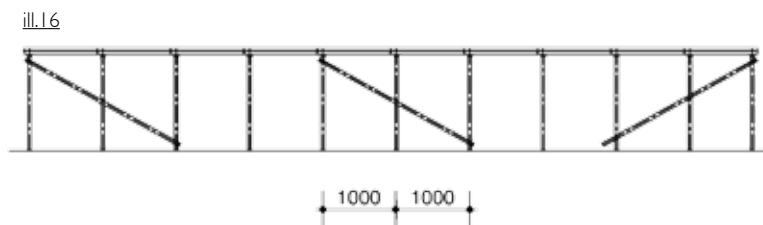
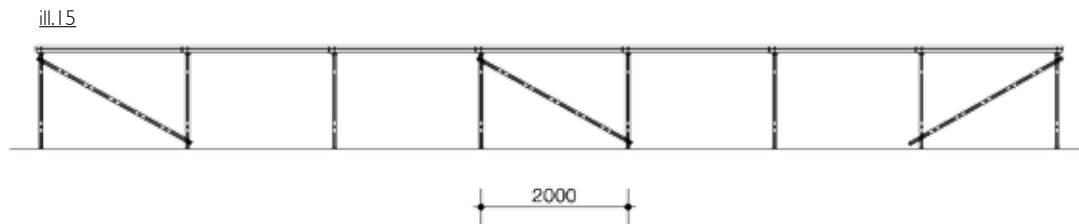

Braces for constructions smaller than 6 x 4 m are to be attached as follows for heights from 80 cm:

- at least one diagonal brace per side
- at sides with 2 m leg distance: covering one bay (see ill. 15)
- at sides with 1 m leg distance: covering one or two bays (see ill. 17 or 16)
- no more than one free bay in a row is allowed all around the construction.

Additional rows or axis of diagonal braces are necessary for stage constructions with extreme differences in relation of width and depth (for example: size 24 x 4 m) in order to achieve sufficient lateral stiffness. Mounting scheme is identical as for stage sides.

Additional horizontal braces at the outside are required when using extension legs at heights exceeding 120 cm – see drawing at the bottom of page 9.

Base constructions for stage heights exceeding 140 cm up to 240 cm require diagonal and horizontal braces - see drawing on page 10.

The same regulations apply for gallery constructions - see drawings on pages 12 - 15.

Stage constructions of nivtec weight girder system in combination with Layher Metric Allround Scaffold System can be built up to a height of 300 cm - see drawings on page 11.

The assembly of your stage constructions has to be executed exclusively according to nivtec instructions. Constructions shown on the following pages are to be considered as review of the various possibilities to build different base constructions of the nivtec staging system in raster 2 x 1 m resp. 2 x 2 m.

Please ask for sample drawings and further information regarding the base construction for your project already during planning period.

## IX. review of stage examples

---

nivtec-stage, example: 6 x 4 m - leg raster 2 x 1 m

stage height: below 80 cm

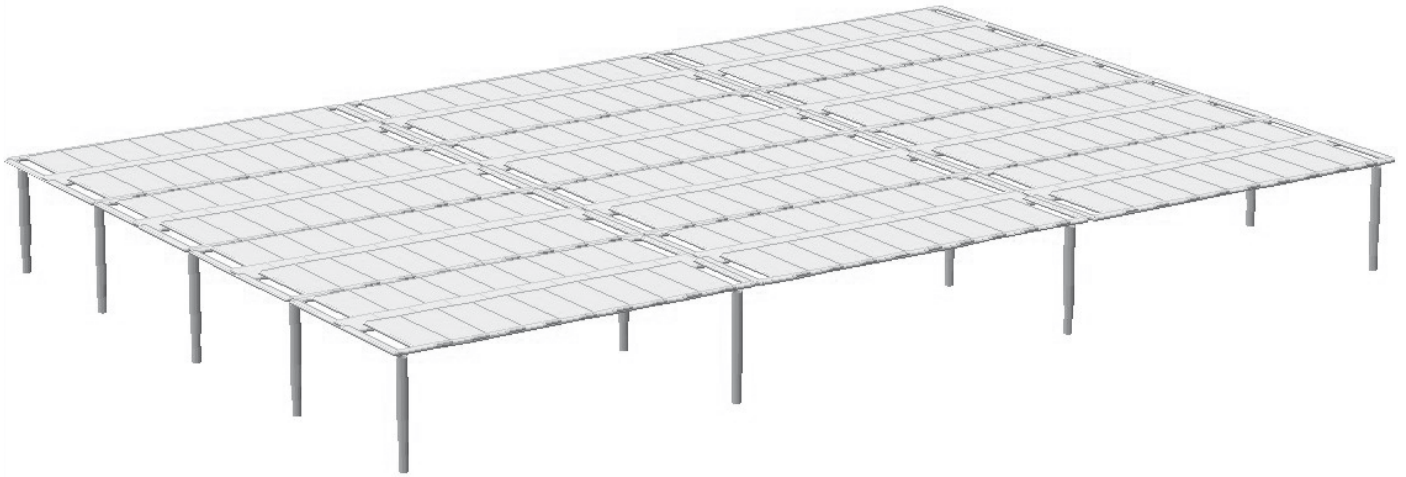

nivtec-stage, example: 6 x 4 m - leg raster 2 x 1 m

stage height: 80 cm

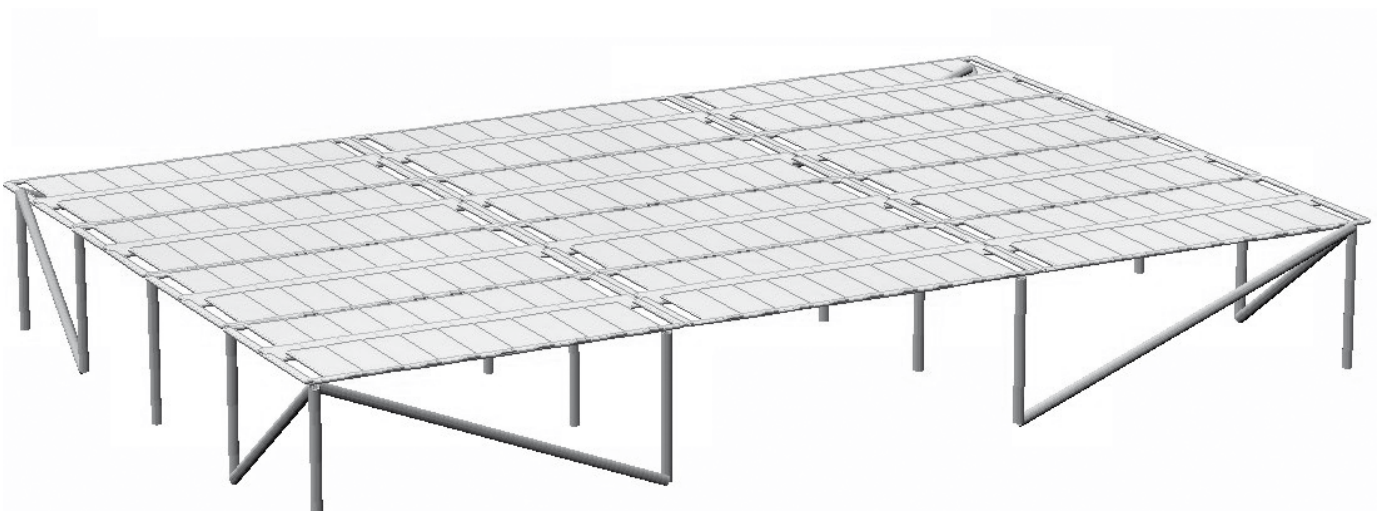



## IX. review of stage examples

---

nivtec-stage, example: 6 x 4 m - leg raster 2 x 1 m

stage height: from 80 cm up to 140 cm

stage height with extension legs: from 80 cm up to 120 cm



nivtec-stage, example: 6 x 4 m - leg raster 2 x 1 m

stage height with extension legs: exceeding 120 cm up to 140 cm

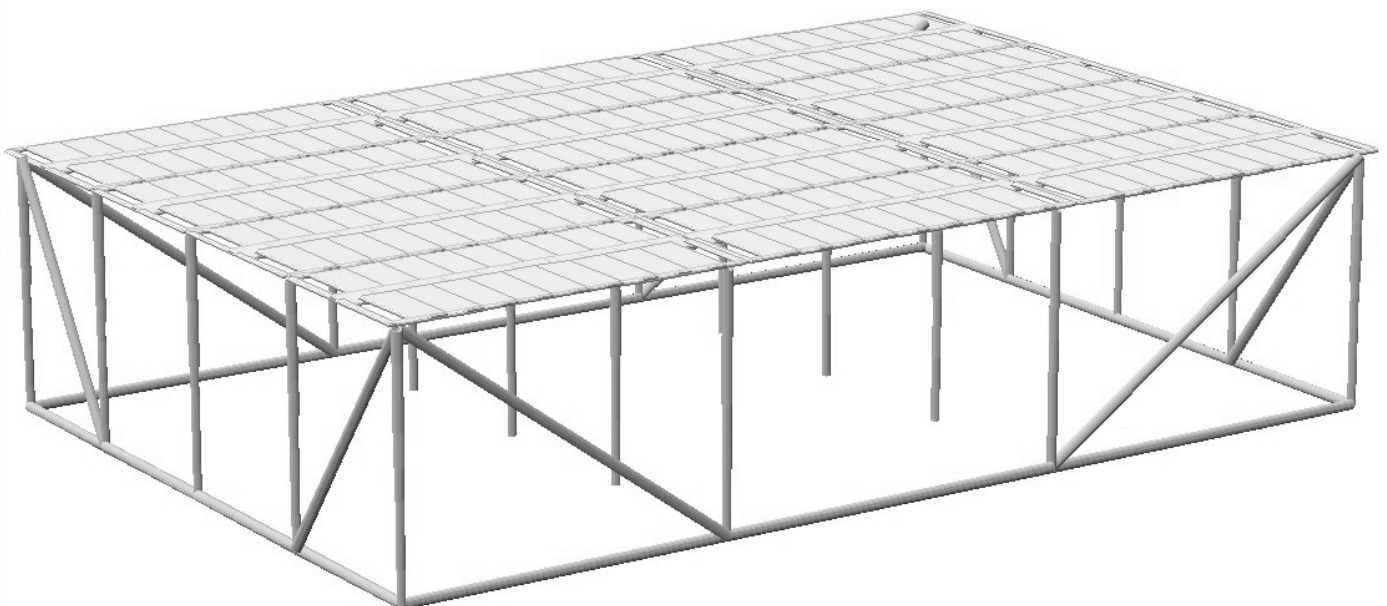

## IX. review of stage examples

---

nivtec-stage, example: 6 x 4 m - leg raster 2 x 1 m

stage height: exceeding 140 cm up to 240 cm



## IX. review of stage examples

---

nivtec-stage with weight girders and Layher base construction  
example: 6 x 6 m - leg raster 2 x 2 m

stage height: 180 cm

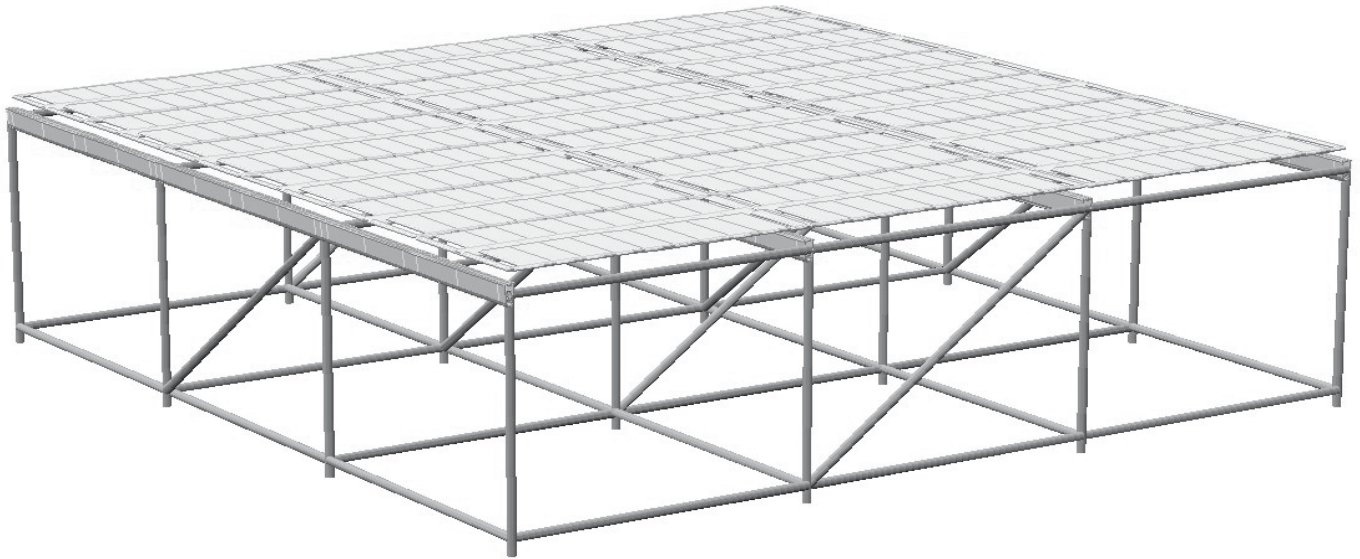

nivtec-stage with weight girders and Layher base construction  
example: 6 x 6 m - leg raster 2 x 2 m

stage height: 300 cm

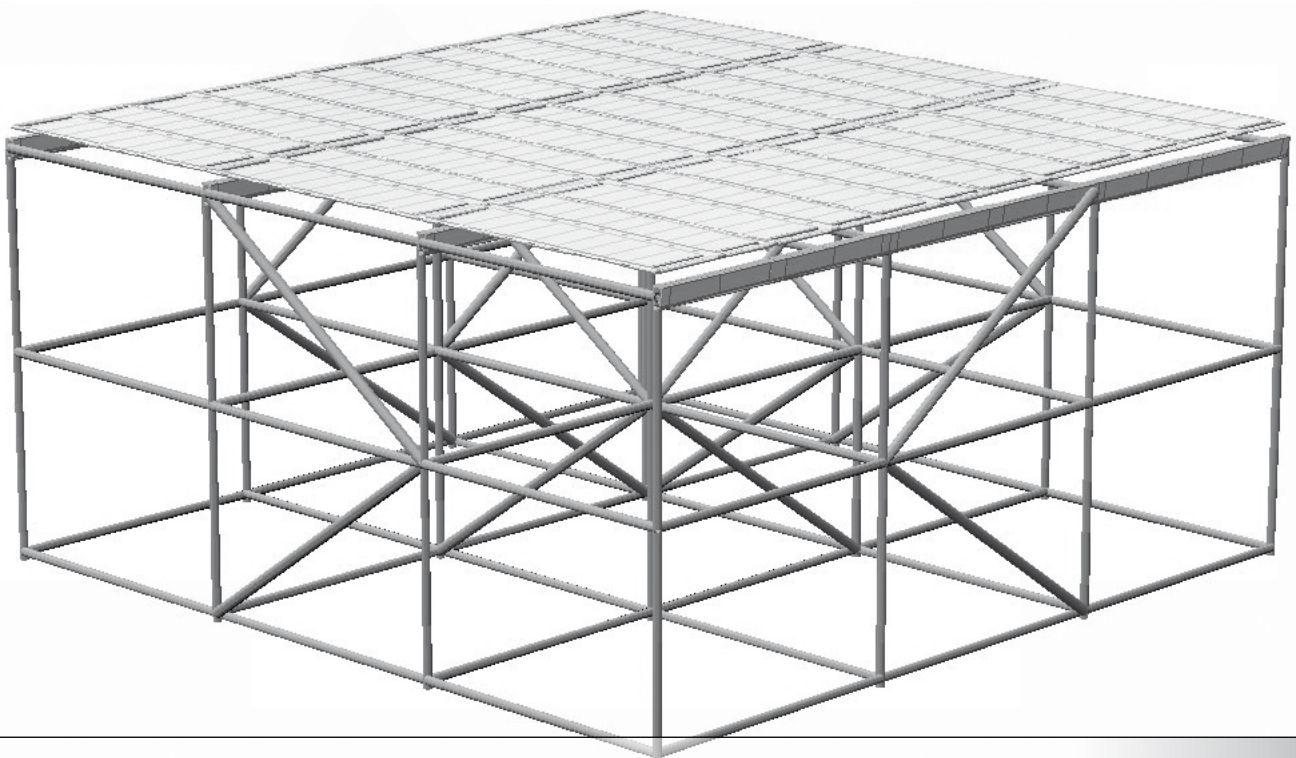

## IX. review of stage examples

---

nivtec-seat gallery

gallery height: 140 cm

tier height: 20 cm

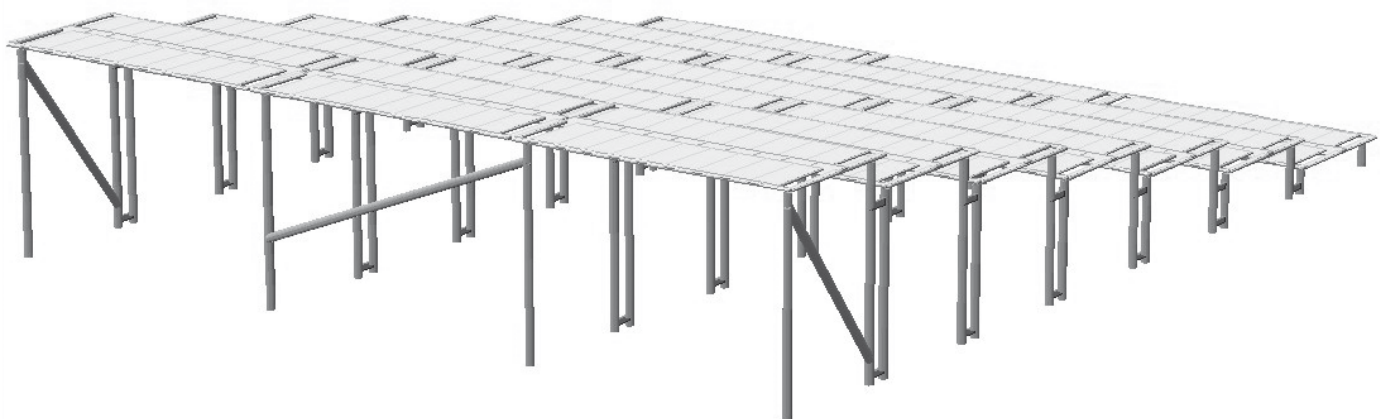
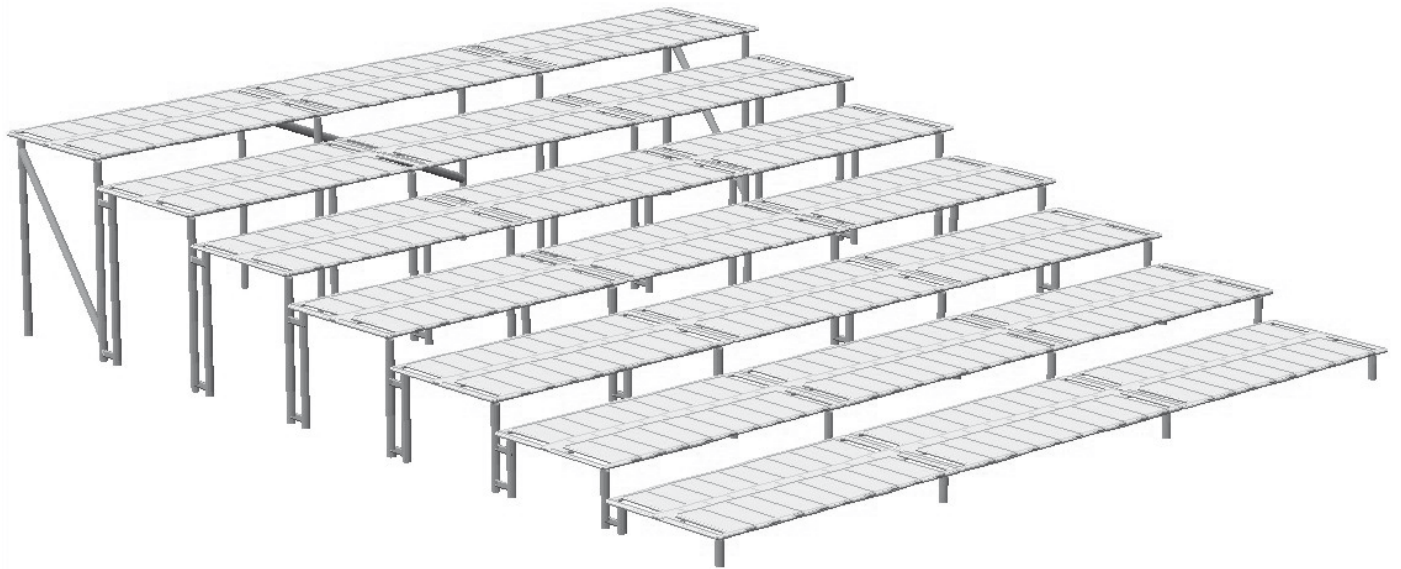

## IX. review of stage examples

---

nivtec-seat gallery

gallery height: 240 cm

tier height: 20 cm

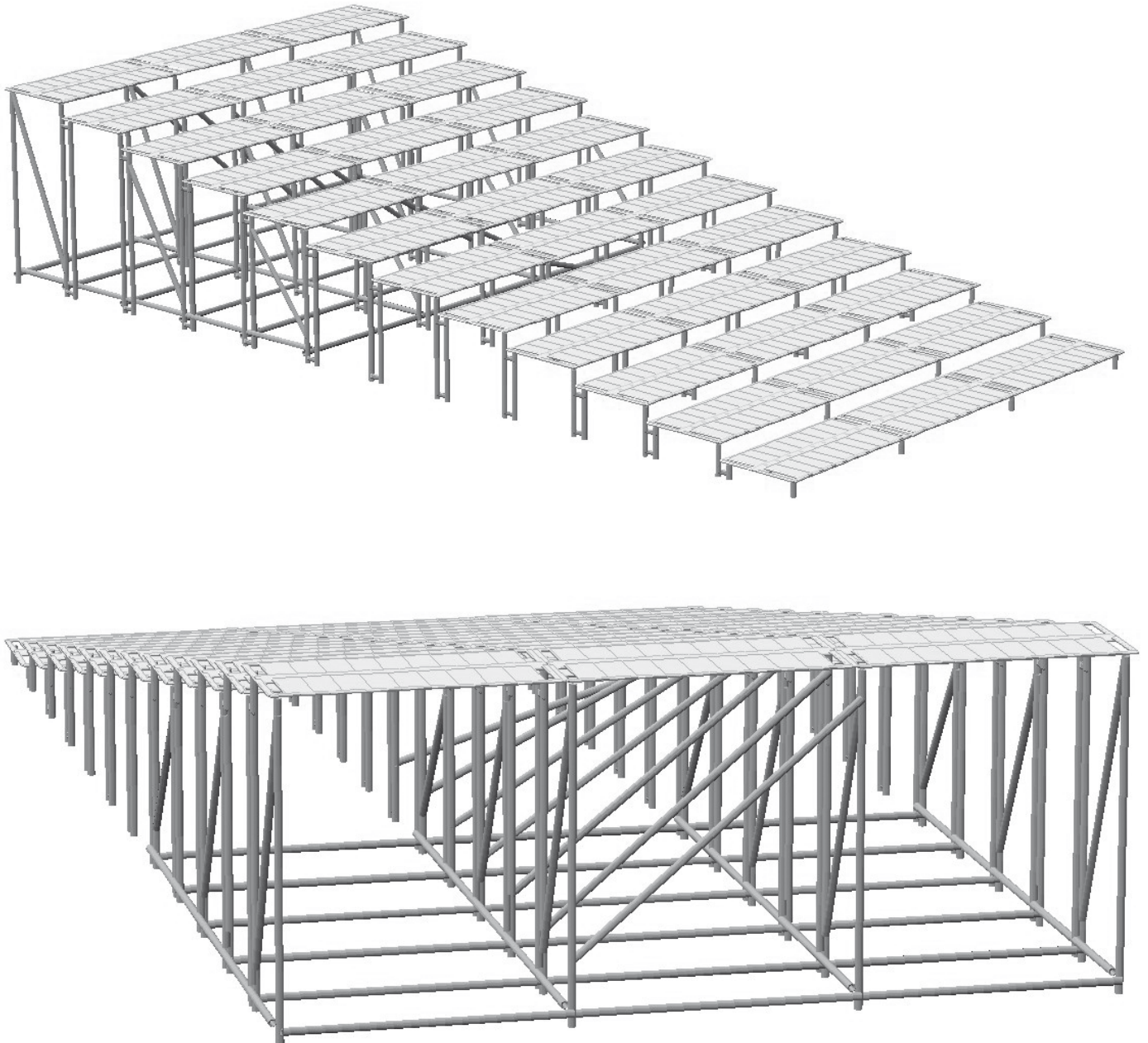

## IX. review of stage examples

---

nivtec-seat gallery

gallery height: 120 cm

tier height: 40 cm

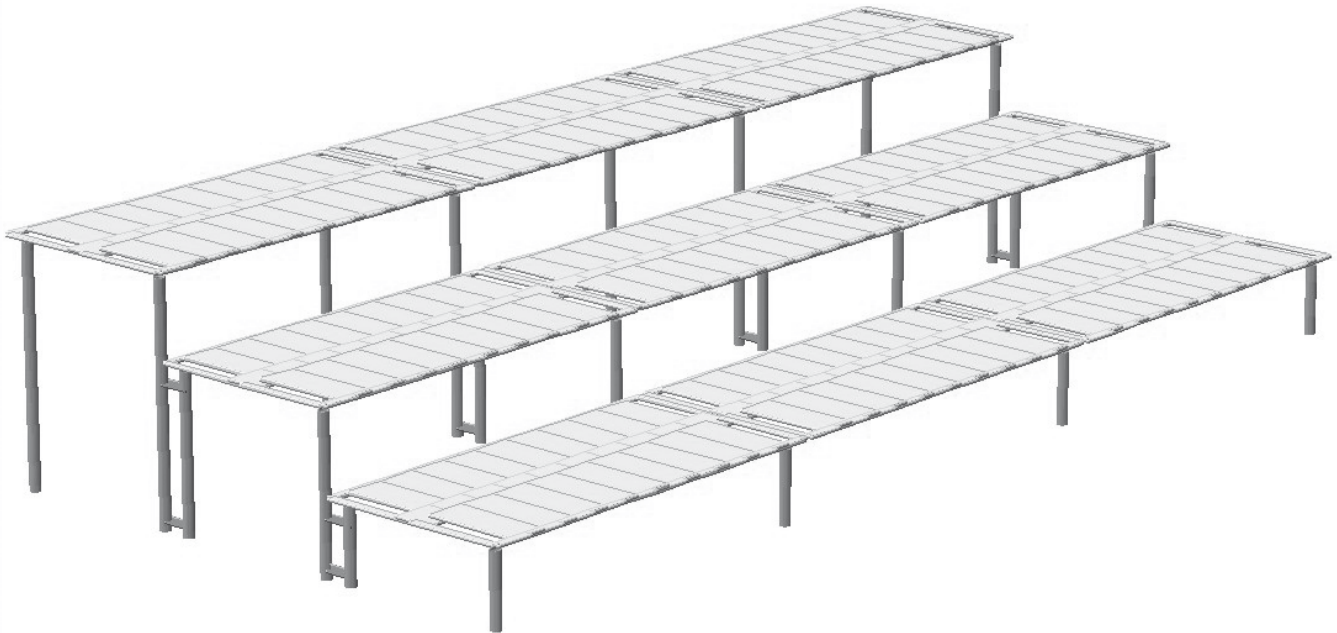

## IX. review of stage examples

---

nivtec-seat gallery

gallery height: 240 cm

tier height: 40 cm

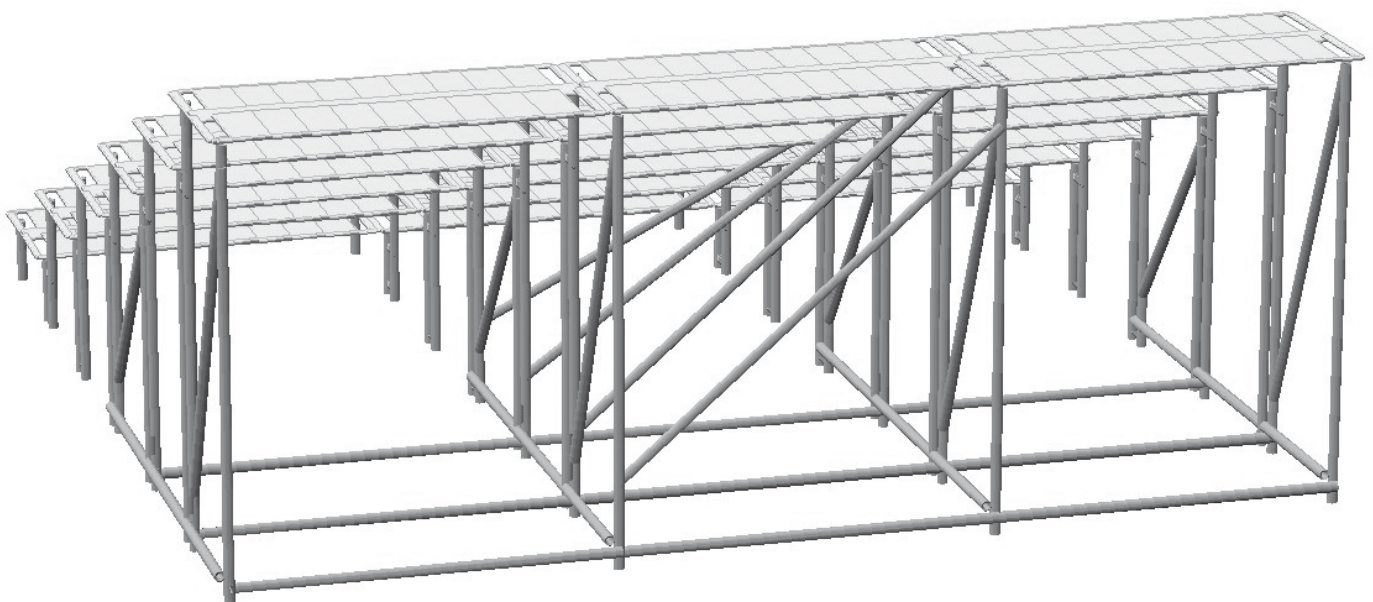
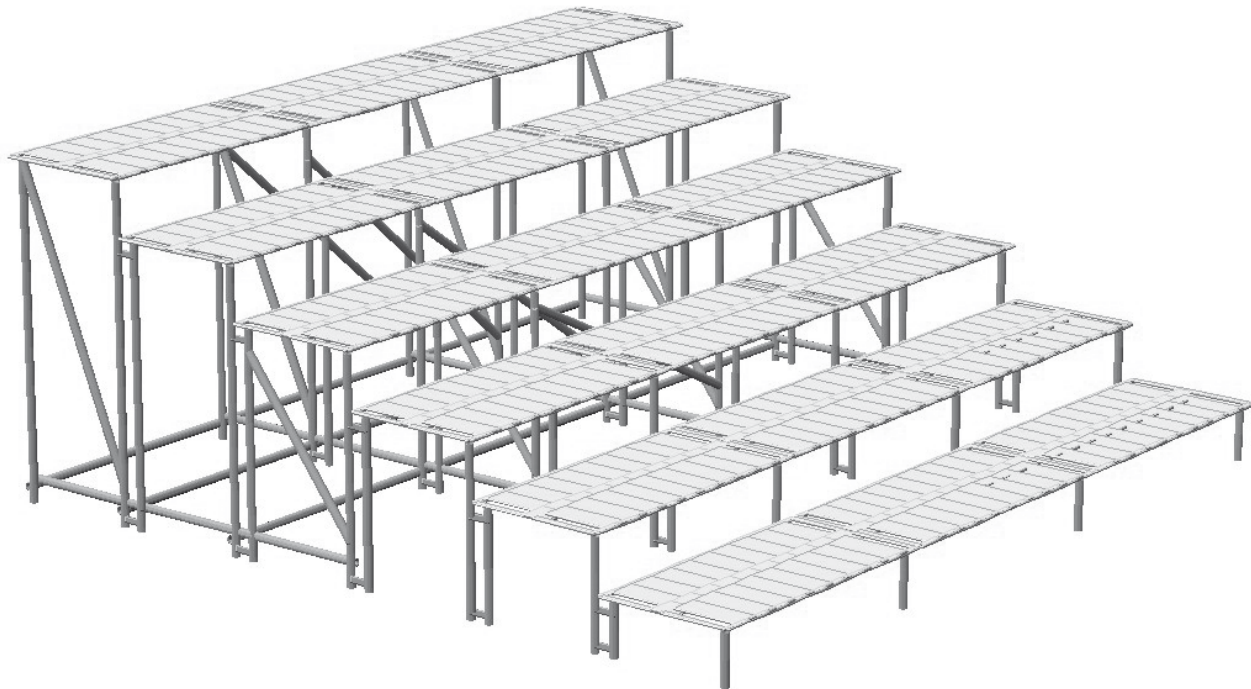

## braces: steel tube 48,3 x 4 mm • diagonal

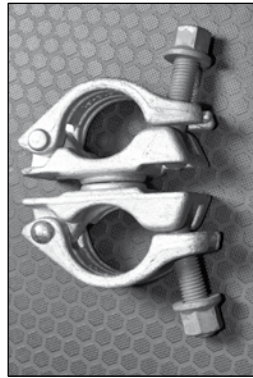

swivel coupling  
Layher 48,3 mm



use with all legs  
at the top

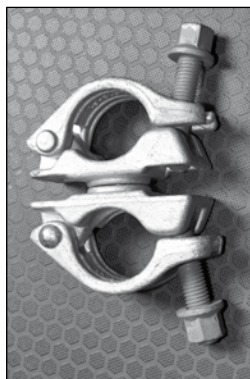

swivel coupling  
Layher 48,3 mm



use at bottom with  
ext. legs at zero adjustment



use with all legs

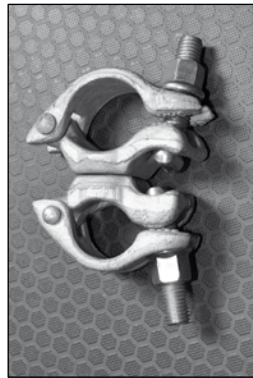

reduction  
swivel coupling



use on inner tubes at  
bottom of

## braces: steel tube 48,3 x 4 mm • horizontal

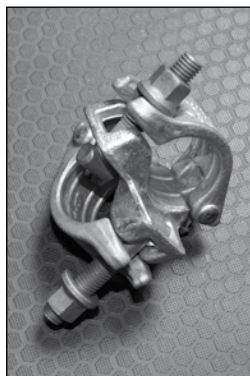

standard coupling  
Layher 48,3 mm



use with all legs



reduction swivel coupling  
except: Plettac 48,3 / 38 mm

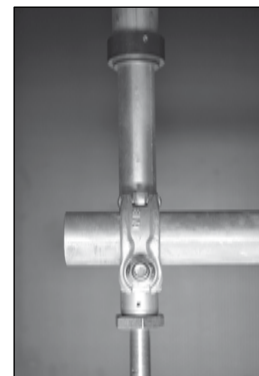

use on inner tubes  
of extension legs